

DECKING FENCING

2015/16



FOR A LIFE
WITHOUT
PAINTING

WOOD
PLASTIC[®]

MANUFACTURER OF COMPOSITE MATERIALS

DISCOVER WoodPlastic® DECKING AND ITS FEATURES

" NATURE'S WORK PERFECTED. "

Fall in love with a material retaining the grace and nobility of wood while eliminating all its shortcomings.

This revolutionary wood-plastic composite material combines wood and a high-quality, non-toxic HDPE polymer at just the right ratio (60:40), making it one of the strongest and most durable low maintenance materials for your decking.

The ideal properties for exterior use were achieved thanks to the revolutionary process and laser technology of Strandex® (USA), which is one of the most advanced WPC technologies owing to many years of development and testing.



Thanks to its sophisticated composition, our decking is highly resistant against the weathering effects of rain, sun, frost and snow, in addition to chlorinated and salt water, wood-decaying fungi, rot and insects. It also resists mechanical damage very much like hardwood.



The WoodPlastic® decking, unlike wooden ones, requires no waxing, oil-coating, or any other kind of surface treatment. Maintenance is easy: simply rinse with flowing water – more time left for fun!



You can believe in WoodPlastic® products. That's why we provide a warranty lasting up to 25 years. Laboratory tests, however, estimate the durability of WoodPlastic® decking to have a very long service life.



WoodPlastic® decking is in original patterns and a very wide selection of colors. It looks and feels like wood. In addition, it contains no toxic substances and is 100% recyclable.



WoodPlastic® decking is equipped with anti-slip surfacing, and unlike wood, never leaves splinters. That makes it completely safe, convenient for walking barefoot, and a perfect fit for your swimming pool or hot tub.



WoodPlastic® products are made in the Czech Republic with US-licensed Strandex technology, which is among the most advanced in the world thanks to many years of development.

CONTENTS

DECKING

- 2/ STAR
- 4/ FOREST
- 6/ FOREST PLUS
- 8/ STYLE PLUS
- 10/ NATURE
- 12/ NATURE PLUS
- 14/ MAX

INSTALLATION AND ACCESSORIES

FENCES

- 18/ INTRODUCTION
- 20/ FENCE SLATS 120
- 22/ FENCE SLATS 70/90

MANUFACTURING

NOT AT ALL!

WOULD YOU MIND?

ARE YOU MADE OF WOOD?

THANKS

YES AND NO

STAR

"CLASSIC AND TIMELESS"

The clean lines of STAR grooved boards will give your decking a classic look. The grooves increase the safety of movement on the decking, thus making the STAR deck boards an ideal option for swimming pools, garden ponds or spa baths. Thanks to their anti-slip surface the grooved boards are also suitable for installation on stairs, garden pavements or piers.

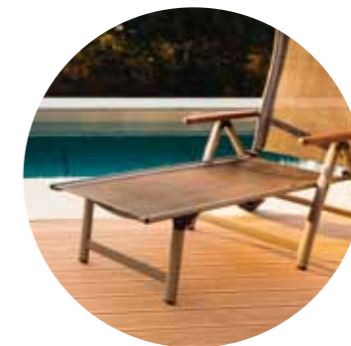

A TIP FOR YOU...



Enjoy an oasis of calm with WoodPlastic® deck boards also on a balcony or roof terrace. A pleasant silence, a feeling of privacy and a beautiful view of the landscape – that's the stuff for beautiful moments with your nearest and dearest. With a guarantee of up to 25 years.



I'M YOUR
STAR

CEDAR

TEAK

MERBAU

PALISANDER

GREY

INOX

EBEN

LATTE

FOREST

"ORIGINAL AND IMPRESSIVE"

FOREST deck boards bring a new, fresh possibility for decking thanks to their distinct, modern structure on the surface of the board. A relief reminiscent of exotic wood will literally enthuse design lovers. When walking on them barefoot you'll be impressed with a perfectly smooth surface, which will please you and your smallest children during their wildest games every time you touch them.

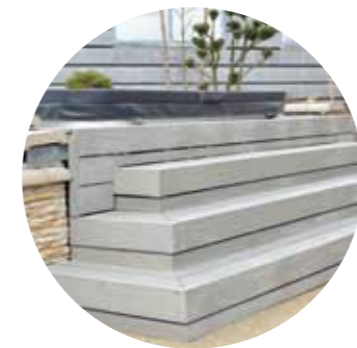

I'M FRESH
AND MODERN

A TIP FOR YOU...

Pay close attention to the selection of comfortable outdoor furniture. Why waste time worrying about your terrace when you can devote all your time to your family and friends at dinners and celebrations together.

CEDAR

TEAK

MERBAU

PALISANDER

GREY

INOX

EBEN

LATTE

FOREST PLUS

"A PEARL AMONG DECKING"

A distinctive surface structure in combination with delicate brindle finish make FOREST PLUS deck boards a design gem. The pigmentation gives the decking a unique luxurious appearance, which is further enhanced by an impression of exotic wood. The breathtaking appearance will delight your refined taste and the pleasantly soft surface will directly stimulate your senses.



I'M
LUXURIOUS BUT
UNDEMANDING

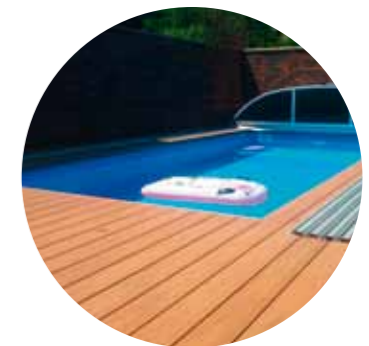
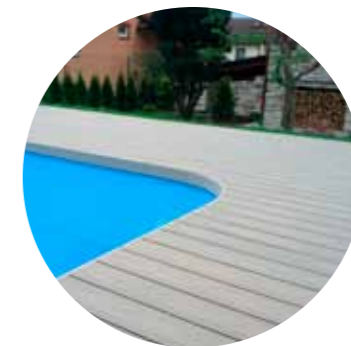
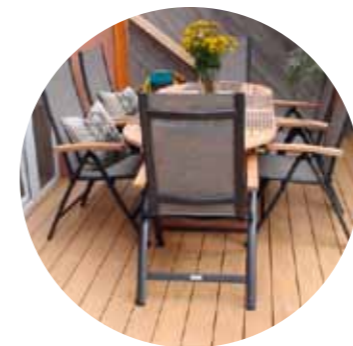

A TIP FOR YOU...

You can support the exclusive impression by using custom length deck boards up to 6 meters in length, which will ensure a lower number of expansion gaps and support the luxurious appearance of the decking.



CEDAR

TEAK

MERBAU

PALISANDER

GREY

INOX

LATTE

STYLE PLUS

"ELEGANCE AND STYLE"

STYLE PLUS deck boards stand out with their smooth surface in combination with unevenly distributed brindle finish. Thanks to sensitively selected coloring, the decking is perfectly suitable for every house or flat regardless of the type of architecture. The smooth, polished relief-free surface will never lose its originality, thus pre-destining the boards for universal use.



I'M BOTH
STYLISH
AND TIMELESS



A TIP FOR YOU...

Smooth STYLE PLUS profiles directly encourage the production of highly durable garden furniture – benches, tables and chairs. Due to the heavier weight you can be sure wind won't take them away. Benches and chairs can be complemented with colorful cushions.



CEDAR

TEAK

MERBAU

PALISANDER

GREY

INOX

LATTE

NATURE

"NATURAL BEAUTY"

NATURE deck boards with a wood grained surface were created for lovers of nature. Take the opportunity to move closer to nature at every free moment. Thanks to a broad range of colors inspired by real woodland trees, as well as a pleasant feel, the imitation of wood is perfect. However, unlike with natural materials you will never have to worry about painting them.



I'M AS BEAUTIFUL AS NATURE ITSELF



A TIP FOR YOU...

Relax on the terrace and enjoy the warm rays of sunshine and the blue sky above. You have nothing else to do! By complementing your terrace with roofing, it will become your favourite room, whether it's summer or winter.



25 YEARS



CEDAR

TEAK

MERBAU

PALISANDER

GREY

INOX

EBEN

LATTE

NATURE PLUS

"INDISTINGUISHABLE
FROM WOOD"

We've elevated the natural beauty and resistance of wood and given rise to NATURE PLUS decking. The authentic appearance of the decking is underlined by a delicate, unevenly distributed brindle finish. In combination with high resistance, permanent colors and a minimum need for maintenance, NATURE PLUS boards make for an excellent alternative to natural material.



A TIP FOR YOU...

Blooming flowers will beautify your terrace. Make flower pots out of WoodPlastic® profiles. You'll appreciate their stability thanks to the greater weight, nearly maintenance-free material and an appearance that is in perfect harmony with your terrace.



I'M MORE
NATURAL THAN
EVER BEFORE...

CEDAR

TEAK

MERBAU

PALISANDER

GREY

INOX

LATTE

MAX

"THE MAXIMUM EFFECT"

A novelty that will enchant you to the MAXimum. An elegant wide MAX board will give an entirely new dimension to your decking – the wider area allows any pattern on the board's surface to stand out much better. What's more, the decking also looks unexpectedly attractive thanks to a lower number of gaps than can be found in decking composed of boards with a narrower profile.



TYPES OF SURFACES



I'M
MAXIMALLY
WIDE

A TIP FOR YOU...



If you're planning to build a staircase connected with your terrace, swimming pool or spa bath, there's nothing easier than choosing an extra wide MAX board. Thanks to its almost 20 cm width, you'll achieve an ideal stringer surface for comfortable movement on the staircase.



25
YEARS



CEDAR

TEAK

MERBAU

PALISANDER

GREY

INOX

EBEN

LATTE

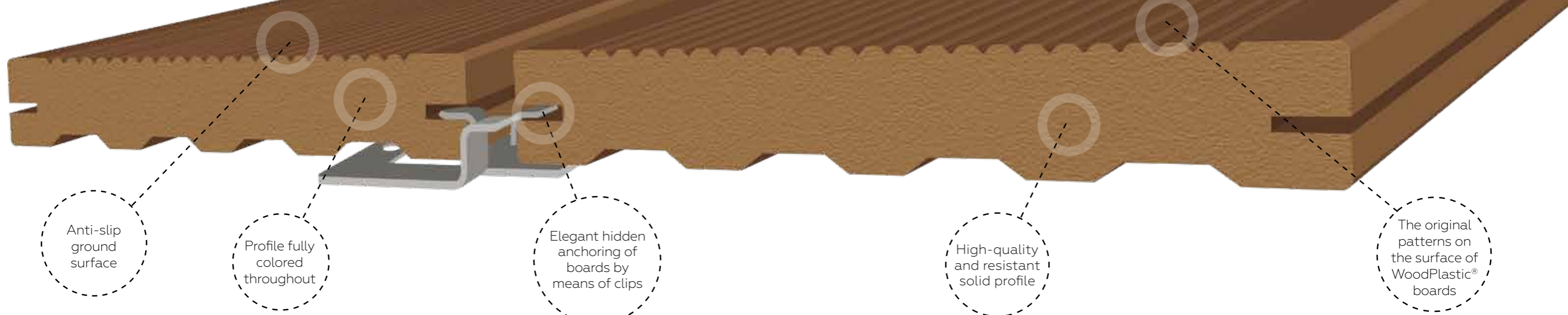

Anti-slip ground surface

Profile fully colored throughout

Elegant hidden anchoring of boards by means of clips

High-quality and resistant solid profile

The original patterns on the surface of WoodPlastic® boards

DO NOT LIMIT YOUR IDEAS AND PLANS

WoodPlastic® profiles offer so many undreamed possibilities. Thanks to their properties and long service life they are suitable to install wherever they can be used as an alternative to wooden products*. So use your imagination and start planning an interesting terrace, fence and other striking exterior elements and details.

* Check specific assembly possibilities with your dealer or manufacturer

IDEAL FOR...

- outdoor terraces and front gardens, entrance flooring
- flooring for gazebos and pergolas, winter gardens
- flooring on balconies, roof terraces
- external flooring leading to swimming pools and garden ponds
- garden paths and pavements
- flooring for wine cellars
- lining around spa baths and stairs
- flooring in garden restaurants
- piers and coastal boardwalks
- garden furniture and benches, garden pots
- terraces in mountain resorts
- and many others...

INSTALLATION AND ACCESSORIES



JOISTS
Our original WoodPlastic® joists serve as a support structure for deck boards*. Choose from two variants:

LARGE JOISTS: 50 x 50 x 3000/4000 mm, Weight: 2.3 kg/lineal meter
SMALL JOISTS: 50 x 30 x 3000/4000 mm, Weight: 1.4 kg/lineal meter



FASTENING MATERIAL
For easy fastening of boards to joists, use stainless steel clips and screws. The installation of boards is carried out using the concealed fastening system.

FASTENING MATERIAL:
Stainless clips
(BASIC, DOUBLE, STARTUP)
Stainless screws



FINISHING BOARDS
Finish the sides of your decking professionally with our WPC profiles.

FINISHING BOARDS
70 x 16 x 2000 mm, 1.35 kg/lineal meter
90 x 16 x 2000 mm, 1.7 kg/lineal meter
137 x 23 x 4000 mm, 3.5 kg/lineal meter
195 x 23 x 4000 mm, 4.9 kg/lineal meter

* Note: Deck boards are not a structural element.

TIPS FOR INSTALLATION



ORIGINAL ATYPICAL SHAPES
The WPC material can be utilized just as with hardwood. It is possible to cut almost any atypical or rounded shapes into the decking, which can even copy moldable edging strips.



ELEGANT LINING AROUND STAIRS
Deck boards make it possible to line stairs connected to a terrace or stairs around a swimming pool or spa bath.



VARIOUS DIRECTIONS OF INSTALLATION
Combine colors and types of boards, install the boards in various directions. The terrace will get a unique look that you will enjoy.

ALWAYS FOLLOW OFFICIAL INSTALLATION INSTRUCTIONS DURING INSTALLATION



DISCOVER WoodPlastic® FENCE SLATS AND THEIR PROPERTIES

Discover revolutionary WoodPlastic® fence slats that perfectly comply with the demands of modern society, and never waste your time painting again.

Fence slats made from wood-plastic composite material manufactured under the Strandex® license are highly resistant to the usual vagaries of the weather, they require no surface treatment, and yet they don't age and maintain their color for a long time. They'll also enchant you with their natural appearance in many color variations and with a great variability of utilisation.

Experience a sense of privacy and security in a modern style. With a guarantee of up to 25 years.

ARE YOU
FRESHLY
PAINTED?

NO, IT ISN'T
NECESSARY
TO PAINT ME



Thanks to its unique composition, WoodPlastic® fence slats are resistant against environmental effects (rain, sunshine, frost and snow), wood-destroying fungus, rot and insects. They are also resistant against mechanical damage, similar to hard wood.



WoodPlastic® fence slats require very little maintenance – just install them and enjoy. They do not require painting, staining or any kind of surface treatment. If necessary, they can simply be washed with water. This will save you a lot of time and money.



You can trust WoodPlastic® products, which is why we offer up to a 25-year warranty period. Laboratory tests have estimated the very long lifetime of WoodPlastic® products.



WoodPlastic® fence slats come with original patterns and a very large assortment of permanent colours. They are indistinguishable from real wood. Our manufacturing is environmentally friendly and the slats are 100% recyclable.



WoodPlastic® fence slats do not splinter, unlike those made of wood. The material is completely safe and does not contain PVC or any toxic materials, so it poses no health risk.



WoodPlastic® products are manufactured in the Czech Republic using the licensed American Strandex technology, whose long development places it among the most modern and reliable in the world.

FENCE SLATS 120

"ATTRACTIVE AND STYLISH"

Fence slats 120 will become the jewel of your garden, whether you choose the more distinct FOREST version with a striking natural surface structure, or the universal, smooth STYLE version. The FOREST PLUS and STYLE PLUS fence slats are enhanced with a delicate brindle finish, which makes them pleasing to the eye and helps to hide small impurities such as dust or pollen.

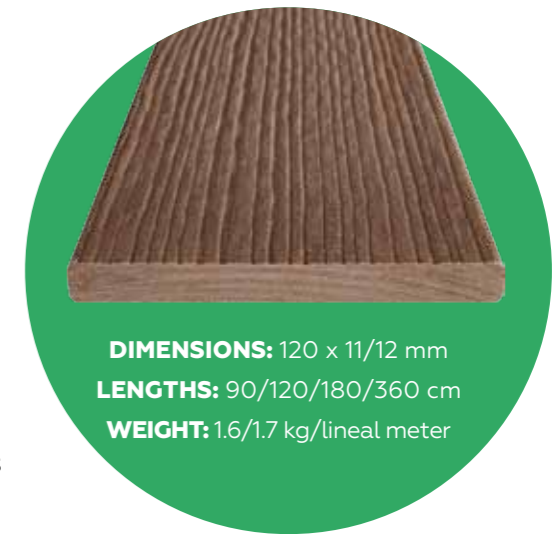

TYPES OF SURFACES



A TIP FOR YOU...



Fence slats 120 will find unexpected use as finishg boards for decking. The weaker profile absolutely pre-destines them for easy shaping and installation around rounded decking corners. Try this profile as a cover strip when connecting decking to a swimming pool.

WE'RE
IMPRESSIVE
AND HAVE
STYLE



FENCE SLATS 90/70

"CLASSICS FOR DISCERNING TASTES"

Fence slats 90 and 70 boast a more robust profile and several types of appearance. It's up to you whether you prefer a more modern appearance provided by the FOREST structure or select the more elegant smooth STYLE surface without any pattern. You can also incline towards nature in the form of NATURE boards, which offer pleasant wood contours.

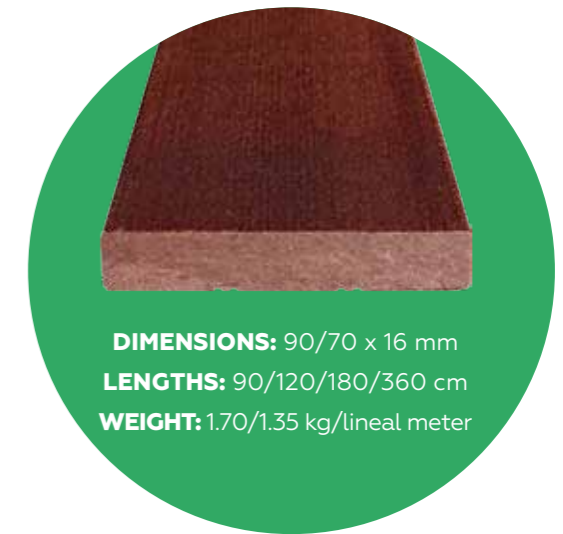

TYPES OF SURFACES



FOREST



STYLE



NATURE

WE'RE
UNIVERSAL AND
PRACTICAL



A TIP FOR YOU...

Don't be afraid to also make use of the fence slats as panels for filling doors, gates, or other fence and garden elements. You can combine the types and color variations of the fence slats to achieve a totally unique look.

MADE IN THE HEART OF EUROPE

WE MANUFACTURE WOODPLASTIC® PRODUCTS IN THE CZECH REPUBLIC UNDER LICENSE OF THE STRANDEX CORPORATION, USA.

We are the only company in Europe to have the laser-controlled Strandex® technology system, which is ranked amongst the most progressive global WPC technologies with maximum precision production in this sector, at our disposal.

The progressive technology, high-quality formula and products of superior quality place us amongst the leading manufacturers and sellers of WPC products in Central Europe.

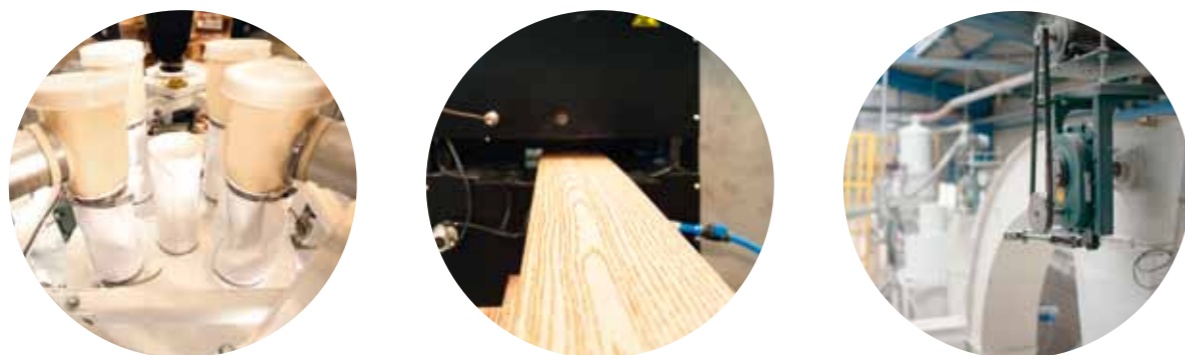

YOU ASK...

■ **What is so unique about the Strandex® technology?**

It is one of the most modern, laser-controlled, extrusion WPC technologies in the world. To achieve maximum accuracy and reliability in production, Strandex® has devoted decades to developing and testing, also on the part of notable US universities.

■ **What are the properties of HDPE polymer and is it safe for human health?**

HDPE is among the ecological, safe for human health and 100% recyclable polymers, which is also used in the health sector. WoodPlastic® products therefore do not contain PVC or toxic substances.

■ **How do you guarantee the WoodPlastic® products for up to 25 years?**

The guarantee is ensured by utilizing one of the most reliable technologies and formulas in the world, rigorously observed procedures and strict quality controls, also on the part of Strandex Corp. Moreover, products made using Strandex technologies have also been successfully tested in various climatic zones – from deserts to rainforests.

READ MORE:



WE ARE HAPPY WHEN SOMEBODY PRAISES US...

THE CONCLUSIONS OF AN ANNUAL TECHNICAL AUDIT PERFORMED BY THE STRANDEX CORPORATION ON OCTOBER 22, 2014, BUKOVANY, CZECH REPUBLIC

The review of finished product quality and testing concluded that all testing equipment is calibrated and is in good operating order. Physical properties of the WPC – WOODPLASTIC a.s. finished product exceed all standards set under the Strandex license. (...) The audit did not find any defects and the WPC – WOODPLASTIC product is of the highest quality. The Strandex Corporation congratulates the staff of WPC – WOODPLASTIC a.s. on its successful operation of the Bukovany facility.

Brian Keller
Strandex Corporation



ISO 9001
ISO 14001
OHSAS 18001
BUREAU VERITAS
Certification



TECHNICAL SPECIFICATIONS



PREMIUM DECK BOARDS	DIMENSIONS	ST. LENGTH	WEIGHT	CAPACITY
STAR	137 x 23 mm	4000 mm	3.5 kg/lm	450 kg/m ²
FOREST	137 x 22 mm	4000 mm	3.2 kg/lm	450 kg/m ²
FOREST PLUS	137 x 22 mm	4000 mm	3.2 kg/lm	450 kg/m ²
STYLE PLUS	137 x 23 mm	4000 mm	3.5 kg/lm	450 kg/m ²
NATURE	137 x 23 mm	4000 mm	3.5 kg/lm	450 kg/m ²
NATURE PLUS	137 x 23 mm	4000 mm	3.5 kg/lm	450 kg/m ²



MAX DECK BOARDS	DIMENSIONS	ST. LENGTH	WEIGHT	CAPACITY
STAR	195 x 23 mm	4000 mm	4.9 kg/lm	450 kg/m ²
FOREST	195 x 22 mm	4000 mm	4.7 kg/lm	450 kg/m ²
FOREST PLUS	195 x 22 mm	4000 mm	4.7 kg/lm	450 kg/m ²
STYLE PLUS	195 x 23 mm	4000 mm	4.9 kg/lm	450 kg/m ²



FENCE SLATS	DIMENSIONS	ST. LENGTH	WEIGHT
FENCE SLATS 120	120 x 12/11 mm	90/120/180/360 cm	1.7 kg/lm
FENCE SLATS 90	90 x 16 mm	90/120/180/360 cm	1.7 kg/lm
FENCE SLATS 70	70 x 16 mm	90/120/180/360 cm	1.35 kg/lm

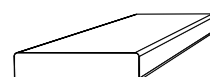

ACCESSORIES	DIMENSIONS	ST. LENGTH	WEIGHT
FINISHING BOARDS			
70	70 x 16 mm	2000 mm	1.35 kg/lm
90	90 x 16 mm	2000 mm	1.7 kg/lm
137	137 x 23 mm	4000 mm	3.5 kg/lm
195	195 x 23 mm	4000 mm	4.9 kg/lm

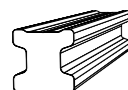

JOISTS	DIMENSIONS	ST. LENGTH	WEIGHT
Large joist	50 x 50 mm	3000mm, 4000 mm	2.3 kg/lm
Small joist	50 x 30 mm	3000mm, 4000 mm	1.4 kg/lm

CLIPS + SCREWS	MATERIAL	NUMBER OF ITEMS IN A PACKAGE
BASIC	stainless steel	100 pcs
DOUBLE	stainless steel	50 pcs
STARTUP	stainless steel	50 pcs

* Applicable values when complying with installation instructions

Variations referred to as "plus" contain brindle finish

MATERIAL CONSUMPTION per m ²	TOLERANCES
PREMIUM DECKING: 7 bm of boards, 2.8 bm of joists, 19 clips	LENGTH +/- 10 mm
MAX DECKING: 5 bm of boards, 2.8 bm of joists, 14 clips	WIDTH +/- 2 mm
	THICKNESS +/- 1 mm

TEST	VALUES
Flexural strength pursuant to ČSN EN 310, conditions pursuant to ČSN PEN/TS 15534-1, Art. 5, 7.3.2.	21.7 MPa
Shrinkage by thermal stress (at 100 degrees Celsius, 60 min, lengthwise direction) pursuant to ČSN EN 479	0.02 %
Impact resistance (resistance against hit by falling weight in cold condition) pursuant to ČSN EN 477	0% of damaged testing bodies
Slipperiness (dry and wet shear friction coefficients) pursuant to ČSN 74 4507	Dry static: 0.50
	Dry dynamic: 0.62
	Wet static: 0.61
	Wet dynamic: 0.51
Swelling in water (28 days, 20 degrees Celsius) pursuant to ČSN EN 317, conditions pursuant to ČSN P CEN/TS 15534-1, Art. 5, 8.3	1.0 %
Swelling after humidity resistance cycle test pursuant to ČSN EN 321	1.1 %
Flexural strength after humidity resistance cycle test pursuant to ČSN EN 321, ČSN P CEN/TS 15534-1, Art. 8.5.1, ČSN EN 310	20.3 MPa
Linear thermal expansion coefficient pursuant to ASTM D696	2.88*10 ⁻² mm/m/°C
Reaction to flame pursuant to ČSN EN 11925-2, ČSN EN ISO 9239-1 ČSN EN	D _{fl} - s1

OTHER TESTS	RESULTS
Bulk density	1210 kg/m ³
Surface hardness (Brinell test)	Very resistant material
Resistance to ligniperdous insects	No attack
Mould resistance N34/EN318	Very resistant material, ageing test without effect

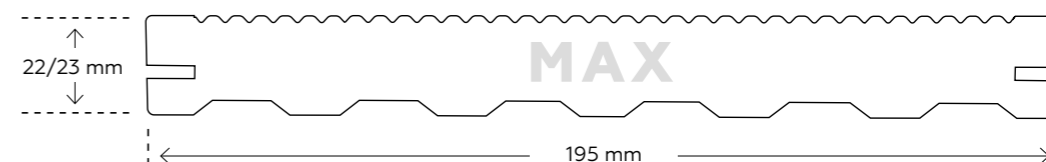
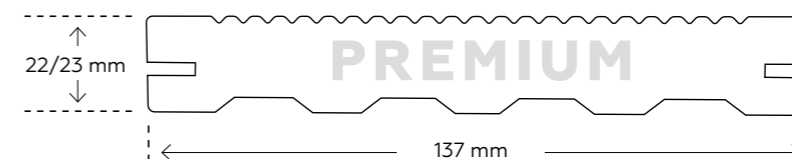

Statement of product conformity with technical regulations is available for the terrace profiles (No. STO – AO 224 – 601/2014). The products were tested by the Testing and Certification Institute in Zlín, Czech Republic and Centrum stavebního inženýrství a.s. - Požární technická laboratoř. WPC – WOODPLASTIC a.s. complies with ISO 9001 standards (Quality Management System), ISO 14001 (Environment Protection System) and OHSAS 18001 (OHS system). The wood used to produce WoodPlastic® products comes from PEFC-certified sources.

WPC – WOODPLASTIC a.s.

Bukovany 181 | 257 41 Týnec nad Sázavou

Czech Republic

info@woodplastic.cz

+420 224 936 841

WWW.WOODPLASTIC.EU



WOOD
PLASTIC[®]

MANUFACTURER OF COMPOSITE MATERIALS